

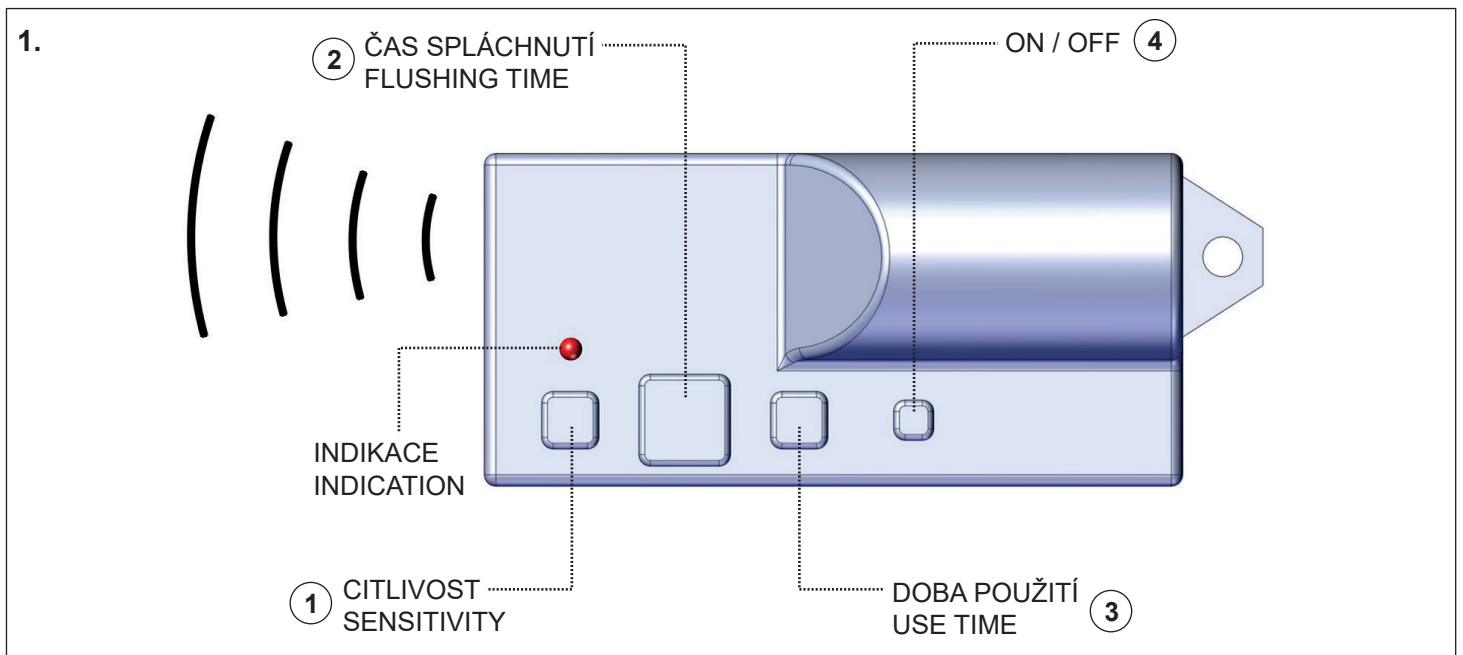

Dálkové ovládání pro nastavení parametrů radarových splachovačů, piezo čidel a termických splachovačů
Remote control for an adjustment of parameters of radar flushing units, piezo controls and thermal flushing devices

Obsah / Table of contents:

1.	Představení ovladače / Remote control introduction.....	1
2.	Princip funkce / Function principle.....	1
3.	Nastavení elektronik s čidly / Sensor electronics settings.....	2
3.1	Nastavování radarových čidel / Radar-controlled sensors settings.....	4
3.2	Nastavování teplotních čidel / Temperature sensors settings.....	5
3.3	Nastavování piezo čidel / Piezo-controlled sensors settings.....	5
4.	Nastavení SLZA 28 / 29 / 29T / SLZA 28 / 29 / 29T settings.....	6
5.	Nastavení SLS 30x / SLS 60x / SLW 30x / SLS 30x / SLS 60x / SLW 30x settings.....	8
6.	ECO mód / ECO mode.....	11



2. (CS) Princip funkce	(RU) Принцип функции	(RO) Principiu de funcționare	(NL) De basis van de werking
(SK) Princip funkcie	(DE) Grundsätzliche Funktionen	(ES) Principio de función	(LT) Veikimo principas
(EN) Principle of function	(PL) Główne funkcje	(FR) Principe de fonctionnement	

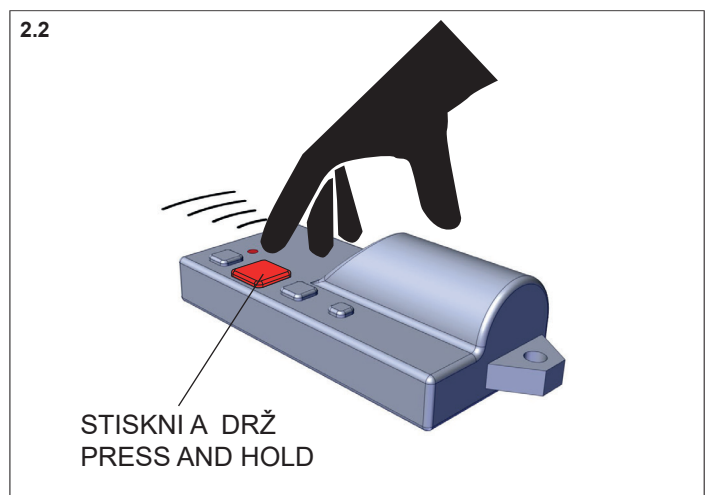
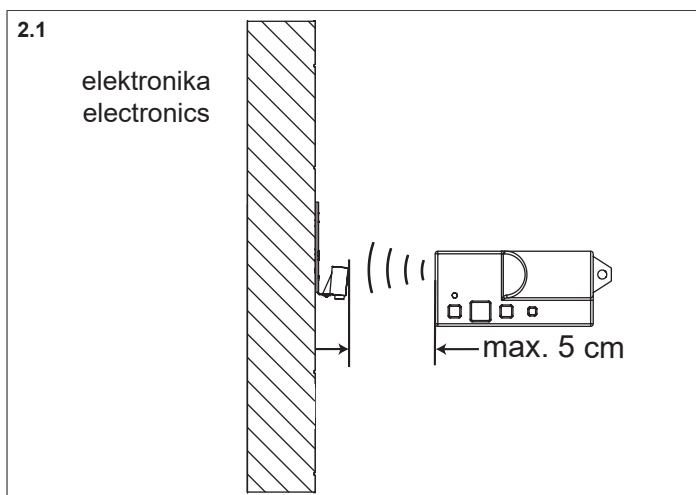

3.	CS Nastavení elektronik s čidly	RO Configurarea electronică cu senzor
	SK Nastavenie elektroniky so senzorom	ES Configuración de la electrónica con el sensor
	EN Sensor electronics settings	FR Réglage de l'électronique avec capteur
	RU Настройка электроники с датчиком	NL Instelling van de elektronica met sensor
	DE Einstellung der Elektronik mit Sensor	LT Elektronikos ir jutiklio konfigūracija
	PL Ustawianie elektroniki z czujnikiem	

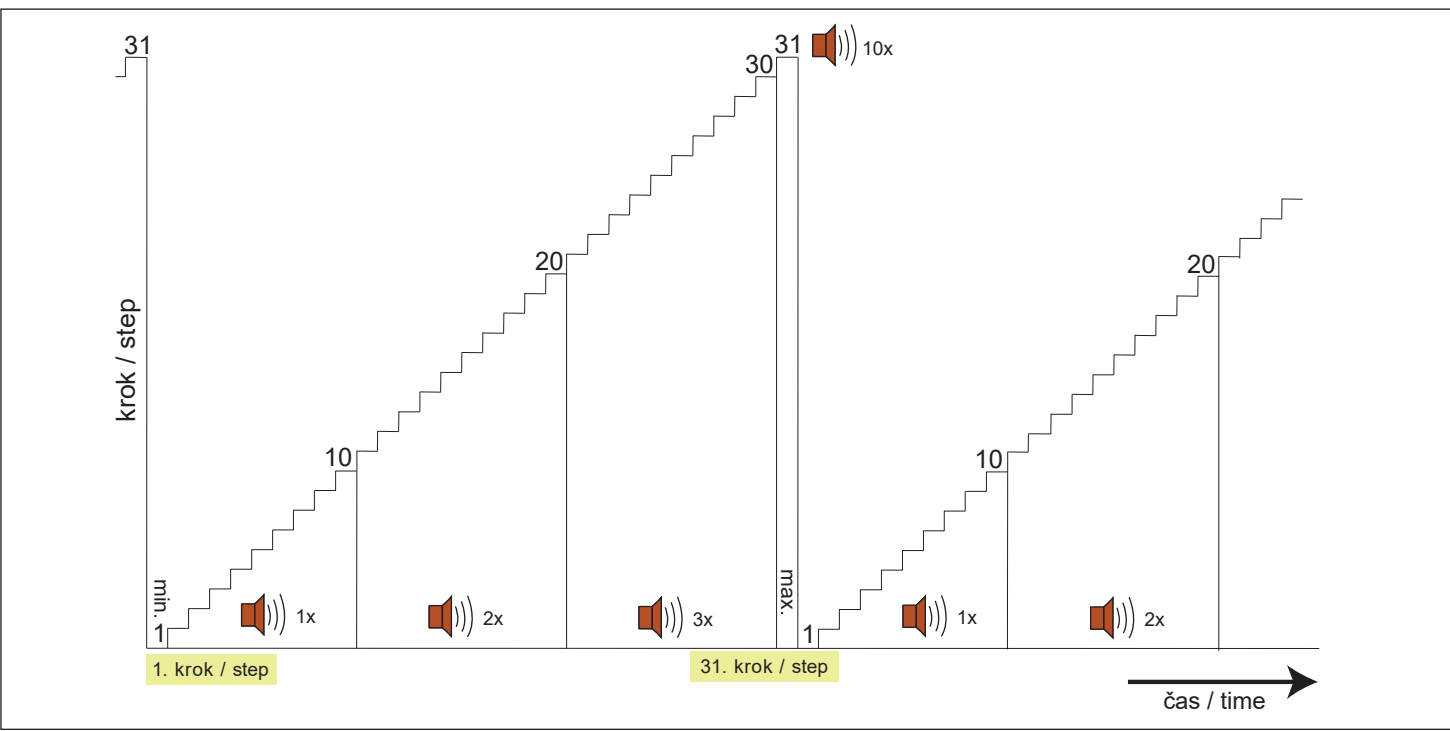
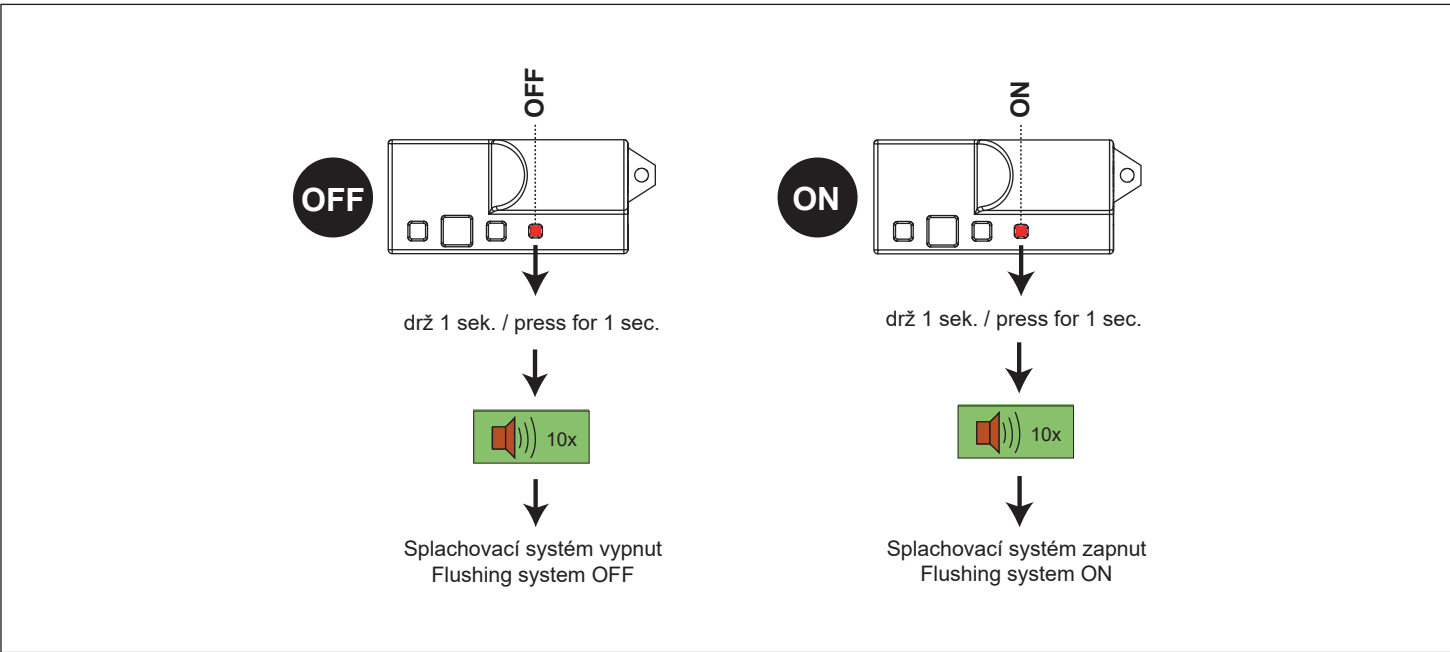

CS Diagram nastavování
SK Diagram nastavovania
EN Settings diagram

RU Диаграм настройки
DE Justier - Diagramm
PL Ustawienie schematu

RO Diagramă setări
ES Diagrama del ajuste
FR Diagramme d'ajustement

NL Schema instellen
LT Nustatymų schema

SLP 07xx, SLP 19xx,
SLP 23xx, SLP 31xx,
SLP 35xx, SLP 36xx,
SLP 53xx, SLP 54xx,
SLP 49xx, SLP 59xx,
SLP 68xx, SLP 69xx,
SLP 70xx, SLP 71xx

SLP 12xx, SLP 20xx,
SLP 24xx, SLP 25xx,
SLP 27xx, SLP 32xx,
SLP 33xx, SLP 37xx,
SLP 60xx, SLPN 02Cx,
SLPN 03Cx, SLPN 04Cx,
SLPN 07Cx, SLPN 09Cx

SLP 02PA, SLP 02NP,
SLS 01Px, SLS 01NPx,
SLS 02Px, SLSN 01Px,
SLSN 02Px, SLU 04Px,
SLU 31Px, SLU 32Px,
SLU 33Px, SLU 44Px,
SLUN 71Px, SLUN 72Px,
SLWN 08LP/PP,
SLWN 18LP/PP,
SLW 01Px

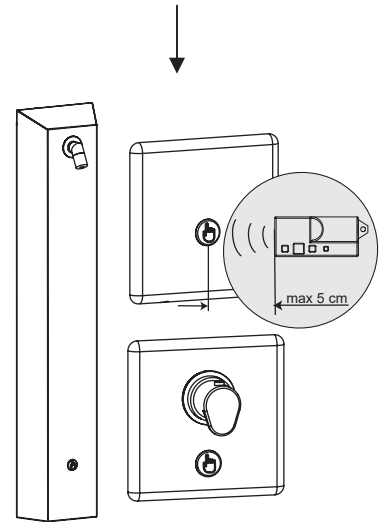
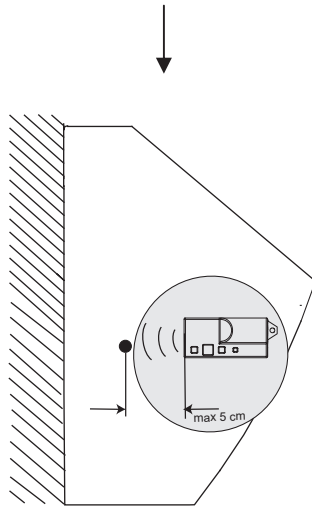
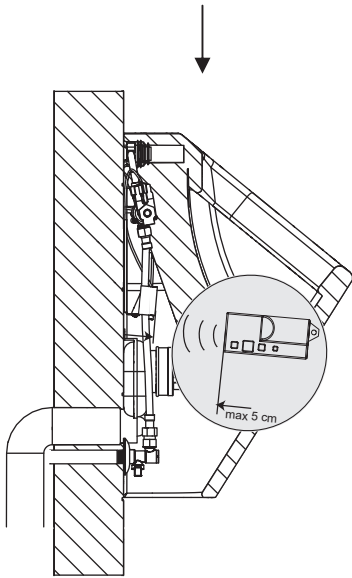

OFF

5 s.

ON



Nastavování radarových čidel
Radar-controlled sensors settings
ODSTAVEC: 3.1
PARAGRAPH: 3.1

Nastavování teplotních čidel
Temperature sensors settings
ODSTAVEC: 3.2
PARAGRAPH: 3.2

Nastavování piezo čidel
Piezo-controlled sensors settings
ODSTAVEC: 3.3
PARAGRAPH: 3.3

NASTAVENÍ DOKONČENO
SETTINGS COMPLETED

20 min.

SLZA 28
SLZA 29
SLZA 29T

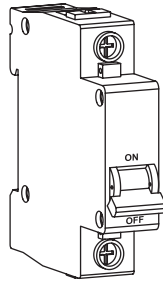

OFF

5 s.

ON

Nastavení SLZA 28/29/29T
SLZA 28/29/29T settings
ODSTAVEC: 4.1
PARAGRAPH: 4.1

NASTAVENÍ DOKONČENO
SETTINGS COMPLETED

20 min.

SLS 30x
SLS 60x
SLW 30x

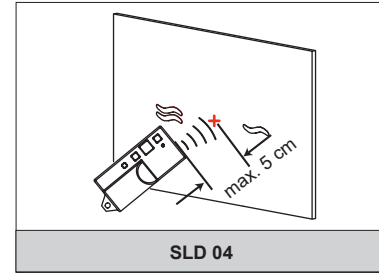

OFF

5 s.

ON

Nastavení SLS 30x, 60x, SLW 30x
SLS 30x, 60x, SLW 30x settings
ODSTAVEC: 5.1
PARAGRAPH: 5.1

NASTAVENÍ DOKONČENO
SETTINGS COMPLETED

20 min.

3.1



- (CS) Nastavování radarových čidel (RU) Настройка радарных датчиков (RO) Reglare parametrii senzor radar (NL) Radar sensor instellingen
 (SK) Nastavovanie radarových čidiel (DE) Radar – Sensor - Justierung (ES) Ajuste de los sensores de radar (LT) Radarinio jutiklio nustatymas
 (EN) Radar-controlled sensors settings (PL) Nastawienie czujnika radarowego (FR) Ajustement du capteur radar

tlačítko button	název funkce function name	počet kroků number of steps	rozsah range	krok step	tovární nastavení factory settings
1.	citlivost sensitivity	31	1 - 31	1	—
2.	doba splachování flushing time	31	0,5 - 15,5 s.	0,5 s.	3 s.
2. (stisknuto před zapnutím napájení / push before switch on power)	interval hygienického proplachu hygienic flush interval	7	OFF/6/8/12/24/ 48/72/168 h.	—	OFF
3.	doba použití use time	9	6 - 10 s.	0,5 s.	10 s.
2.+3.	reset do továrního nastavení return to factory adjustment			—	

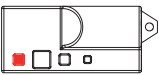
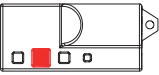
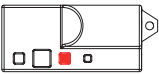
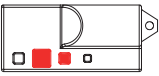
Nastavení ECO módu
ECO mode settings
ODSTAVEC: 6
PARAGRAPH: 6

tlačítko button	název funkce function name	počet kroků number of steps	rozsah range	krok step	tovární nastavení factory settings
1. 	citlivost sensitivity	31	1 - 31	1	—
2. 	doba splachování flushing time	31	0,5 - 15,5 s.	0,5 s.	5 s.
2. (stisknuto před zapnutím napájení / push before switch on power)	interval hygienického proplachu hygienic flush interval	7	OFF/6/8/12/24/ 48/72/168 h.	—	OFF
3. 	doba použití use time	31	15 - 75 s.	2 s.	25 s.
2.+3. 	reset do továrního nastavení return to factory adjustment	—			

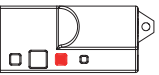
Nastavení ECO módu
ECO mode settings
ODSTAVEC: 6
PARAGRAPH: 6

tlačítko button	název funkce function name		umyvadlo washbasin	sprcha shower	pisoiár urinal	WC toilet	
2. 	doba splachování flushing time	počet kroků number of steps	31				
		rozsah range	2 - 62 s.	10 - 310 s.	0,5 - 15,5 s.		
		krok step	2 s.	10 s.	0,5 s.		
		tovární nastavení factory settings	10 s.	120 s.	4 s.	8 s. (SLW 01Px) 5 s. (SLW 02PA/03PA/04PA)	
3. 	interval hygienického proplachu hygienic flush interval	počet kroků number of steps	7		4		
		rozsah range	OFF, 6 h., 8 h., 12 h., 24 h., 72 h., 7 d.		24/48/72 h./OFF	24 h. / 8 splách./flushes, 24 h. + 8 splách./ flushes, OFF	
		krok step	—				
		tovární nastavení factory settings	OFF		24 h.	24 h. / 8 splách./flushes	
1.+4. 	délka hygienického proplachu the length of hygienic flush	počet kroků number of steps	31				
		rozsah range	5 - 1200 s.				
		č. kroku/čas/krok step nr./time/step	1 - 6	5 - 30 s.	5 s.		
			7 - 12	40 - 90 s.	10 s.		
			13 - 21	120 - 360 s.	30 s.		
22 - 30	420 - 900 s.	60 s.					
31	1200 s.	—					
tovární nastavení factory settings	—						

- | | | | | |
|----|----------------------|-----------------------|-------------------|------------------------|
| 4. | CS Nastavení | RU Настройка | RO Reglaj | NL Afstelling |
| | SK Nastavenie | DE Einstellung | ES Ajuste | LT Reguliavimas |
| | EN Settings | PL Regulacja | FR Réglage | |

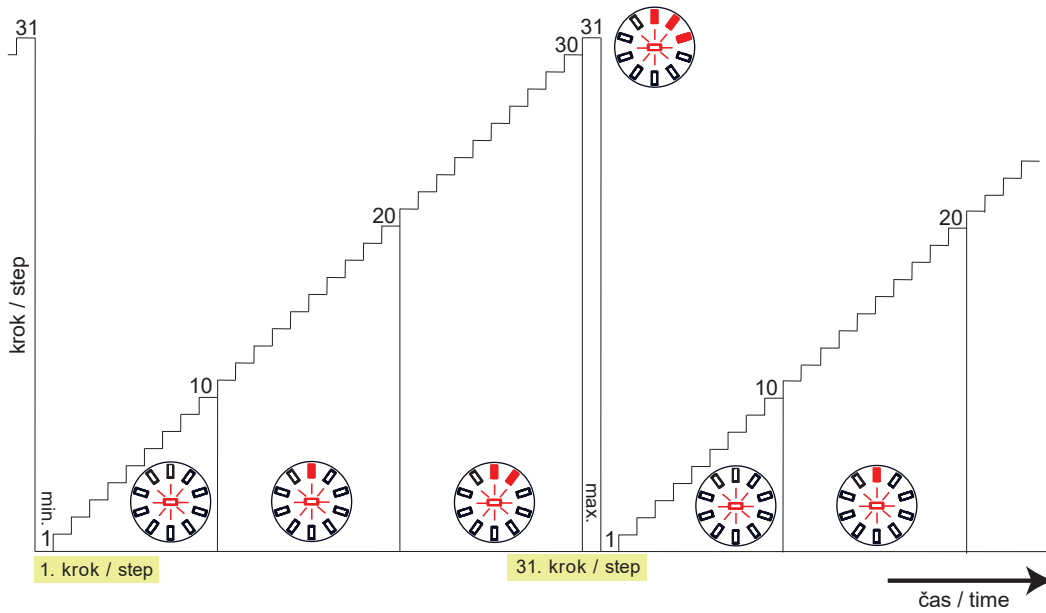
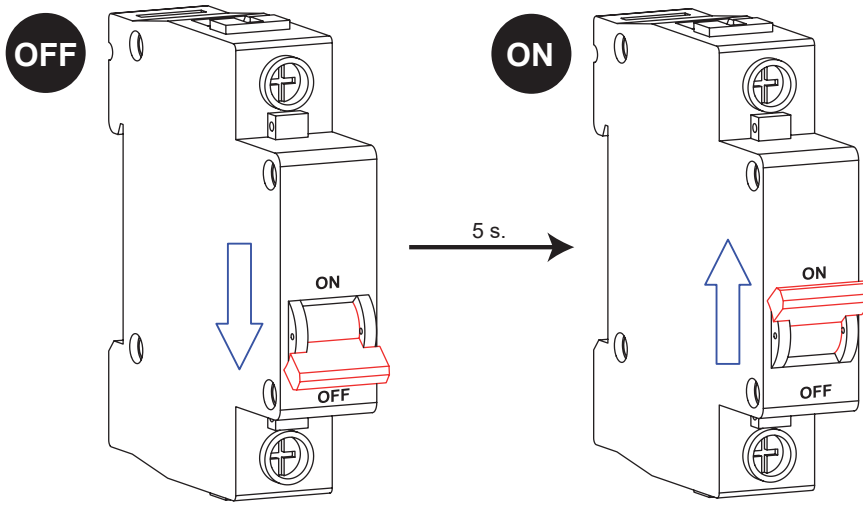

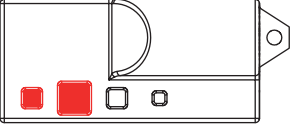
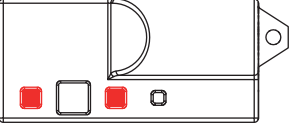
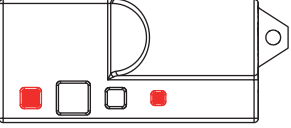
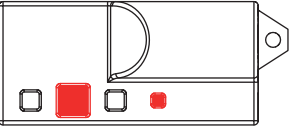
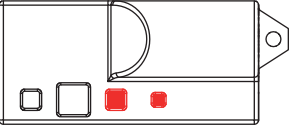
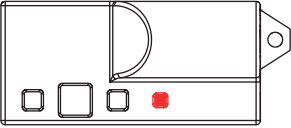
4.1	tlačítko button	název funkce function name		
1.+2.		délka sepnutí ventilu valve switch-on time	počet kroků number of steps rozsah range krok step tovární nastavení factory settings	31 10 - 1200 s. viz tabulka č. 2 see table No. 2 120 s.
1.+3.		interval hygienického proplachu hygienic flush interval	počet kroků number of steps rozsah range krok step tovární nastavení factory settings	7 OFF, 6 h, 8 h, 12 h, 24 h, 72 h, 7 d — OFF
1.+4.		délka hygienického proplachu the length of hygienic flush	počet kroků number of steps rozsah range krok step tovární nastavení factory settings	31 5 - 1200 s. viz tabulka č. 1 see table No. 1 5 s.
2.+4.		vyprázdnění RFID slotu RFID slot emptying	počet kroků number of steps rozsah range krok step tovární nastavení factory settings	—
3.+4.		sprcha zdarma free shower	počet kroků number of steps rozsah range krok step tovární nastavení factory settings	2 OFF / ON — OFF
4.		vypnutí / zapnutí sprchy shower OFF/ON	počet kroků number of steps rozsah range krok step tovární nastavení factory settings	2 OFF / ON — ON

5.

CS Nastavení
SK Nastavenie
EN Settings

RU Настройка
DE Einstellung
PL Regulacja

RO Reglaj
ES Ajuste
FR Réglage

NL Afstelling
LT Reguliavimas

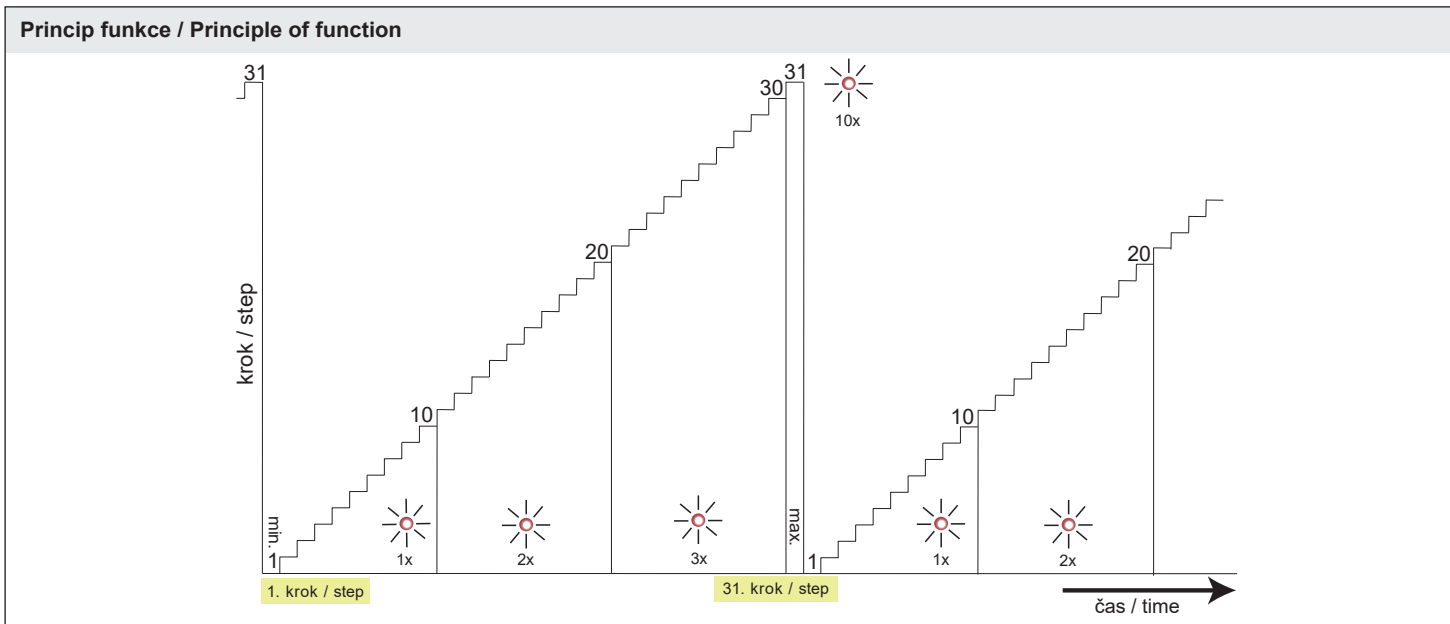
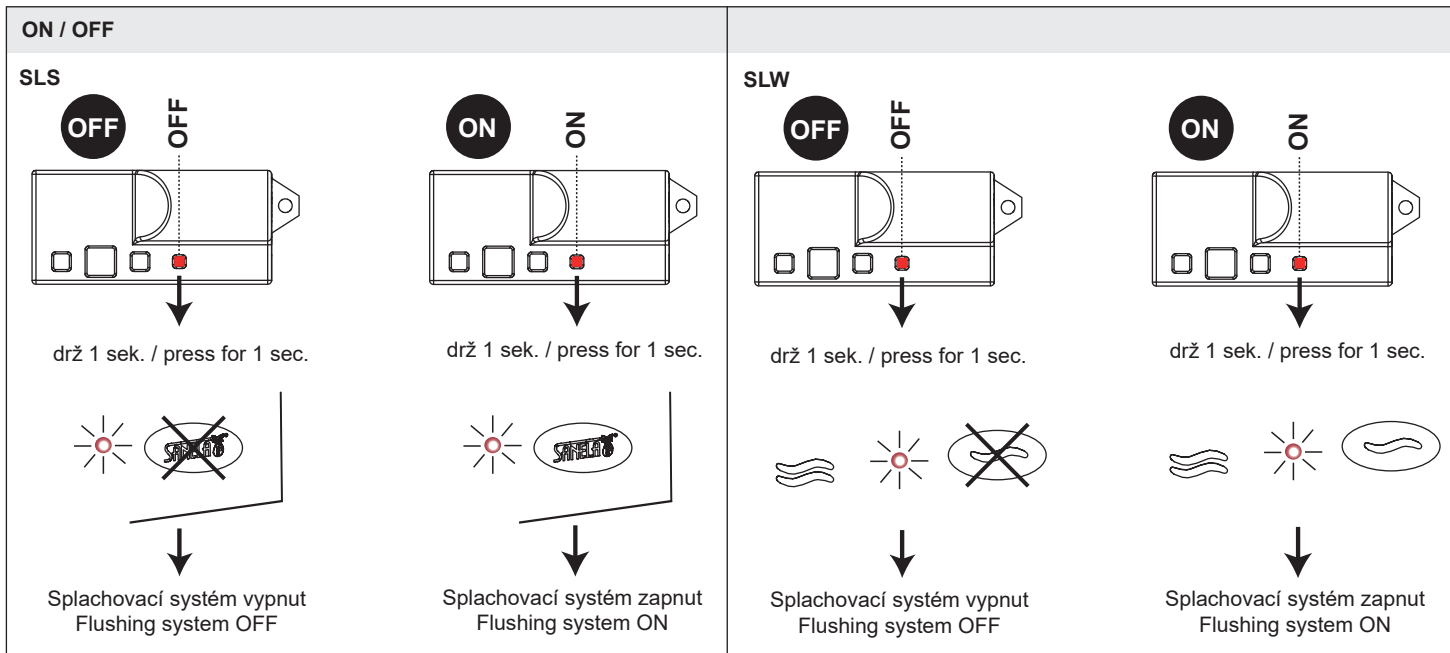

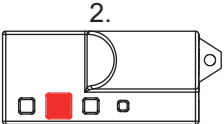
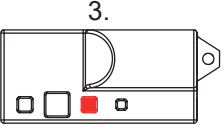
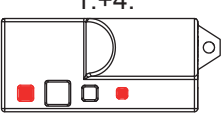
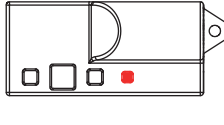
5.1	tlačítko button	název funkce function name		SLS 30x	SLS 60x	SLW 30x
		délka sepnutí ventilu valve switch-on time	počet kroků number of steps	31		
			rozsah range	5 - 1200 s.	5 - 155 s.	1 - 31 s.
			krok step	viz tabulka č. 1 see table No. 1		
			tovární nastavení factory settings	120 s.	30 s.	10 s.
		interval hygienického proplachu hygienic flush interval	počet kroků number of steps	7		4
			rozsah range	OFF, 6 h, 8 h 12 h, 24 h, 72 h, 7 d		24 h./8splách./flushes 24 h. i 8 splách./ flushes, OFF
			krok step	—		
			tovární nastavení factory settings	OFF		
		délka hygienického proplachu the length of hygienic flush	počet kroků number of steps	31		
			rozsah range	5 - 1200 s.		
			krok step	viz tabulka č. 1 see table No. 1		
			tovární nastavení factory settings	5 s.		
		vypnutí / zapnutí sprchy shower OFF/ON	počet kroků number of steps	2		
			rozsah range	OFF / ON		
			krok step	—		
			tovární nastavení factory settings	ON		

(tabulka č. 1 / table No. 1)

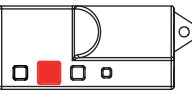
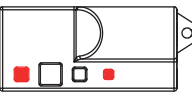
tlačítko button	název funkce function name	počet kroků number of steps	rozsah range	č. kroku step nr.	čas time	tovární nastavení factory settings
 	délka sepnutí ventilu valve switch-on time	31	5 - 1200 s.	1	5 s.	5 s.
				2	10 s.	
				3	15 s.	
				4	20 s.	
				5	25 s.	
				6	30 s.	
				7	40 s.	
				8	50 s.	
				9	60 s.	
				10	70 s.	
				11	80 s.	
				12	90 s.	
				13	120 s.	
				14	150 s.	
				15	180 s.	
				16	210 s.	
				17	240 s.	
				18	270 s.	
				19	300 s.	
				20	330 s.	
				21	360 s.	
				22	420 s.	
				23	480 s.	
				24	540 s.	
				25	600 s.	
				26	660 s.	
				27	720 s.	
				28	780 s.	
				29	840 s.	
				30	900 s.	
				31	1200 s.	

(tabulka č. 2 / table No. 2)

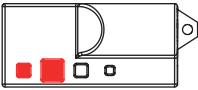
tlačítko button	název funkce function name	počet kroků number of steps	rozsah range	č. kroku step nr.	čas time	tovární nastavení factory settings
<p>1.+2.</p> 	<p>délka sepnutí ventilu valve switch-on time</p>	<p>31</p>	<p>10 - 1200 s.</p>	1	10 s.	<p>120 s.</p>
				2	20 s.	
				3	30 s.	
				4	40 s.	
				5	50 s.	
				6	60 s.	
				7	70 s.	
				8	80 s.	
				9	90 s.	
				10	100 s.	
				11	110 s.	
				12	120 s.	
				13	130 s.	
				14	150 s.	
				15	180 s.	
				16	210 s.	
				17	240 s.	
				18	270 s.	
				19	300 s.	
				20	330 s.	
				21	360 s.	
				22	420 s.	
				23	480 s.	
				24	540 s.	
				25	600 s.	
				26	660 s.	
				27	720 s.	
				28	780 s.	
				29	840 s.	
				30	900 s.	
				31	1200 s.	

6.	CS ECO mód	RU ЭКО-режим	RO Mod ECO	NL ECO-modus
	SK ECO mód	DE ECO-Modus	ES Modo ECO	LT ECO režims
	EN ECO mode	PL Tryb ECO	FR Mode ÉCO	

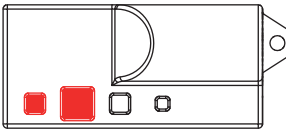
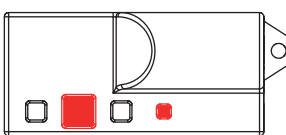
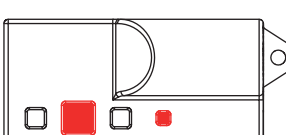
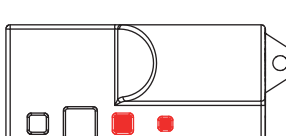
tlačítko button	název funkce function name		
1.+2. 	vypnutí / přepínání OFF / mode change	počet kroků number of steps	3
		rozsah range	mód 1 / 2 / OFF mode 1 / 2 / OFF
		krok step	—
		tovární nastavení factory settings	OFF
2.+4. 	doba mezi spláchnutím time between flushes	počet kroků number of steps	31
		rozsah range	5 - 1200 s.
		krok step	viz tabulka č. 3 see table no. 3
		tovární nastavení factory settings	300 s.
2.+4. 	délka krátkého spláchnutí duration of short flush	počet kroků number of steps	31
		rozsah range	0,5 - 15, 5 s.
		krok step	0,5 s.
		tovární nastavení factory settings	1 s.
3.+4. 	počet použití number of uses	počet kroků number of steps	30
		rozsah range	1 - 30
		krok step	1
		tovární nastavení factory settings	10

(tabulka č. 3 / table No. 3)

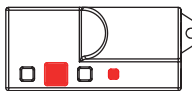
tlačítko button	název funkce function name	počet kroků number of steps	rozsah range	č. kroku step nr.	čas time	tovární nastavení factory settings
2.+4. 	doba mezi spláchnutím time between flushes	31	5 - 1200 s.	1	5 s.	300 s.
				2	10 s.	
				3	15 s.	
				4	20 s.	
				5	25 s.	
				6	30 s.	
				7	40 s.	
				8	50 s.	
				9	60 s.	
				10	70 s.	
				11	80 s.	
				12	90 s.	
				13	120 s.	
				14	150 s.	
				15	180 s.	
				16	210 s.	
				17	240 s.	
				18	270 s.	
				19	300 s.	
				20	330 s.	
				21	360 s.	
				22	420 s.	
				23	480 s.	
				24	540 s.	
				25	600 s.	
				26	660 s.	
				27	720 s.	
				28	780 s.	
				29	840 s.	
				30	900 s.	
				31	1200 s.	